

Investigating the Biological Impacts of Radio Spectrum

The bee project group



Murtadha



Tom



Justin



Joseph

Undergraduate Students:

Zhenzhou (Tom) Qi

Joseph Florentine

Justin Yu

Graduate Student:

Murtadha Aldeer

Advisors:

Richard Martin & Richard Howard

Website: <https://www.orbit-lab.org/wiki/Other/Summer/2020/Bees>

Objectives

- Bees use Earth's magnetic field for navigation and orientation.
- We seek to explore if the bees can detect dynamic signals!

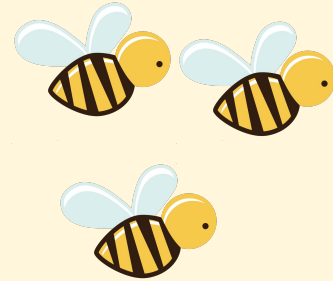

Our approach

- Expose bees to static and dynamic magnetic (B) fields
 - Static fields first, then test RF
- Positive and negative reinforcement learning
 - Sugar water (reward) while RF is ON
 - Bitter water (punishment) while RF is OFF
- In-the-wild experiment
 - No capture/release
 - Not in controlled lab environment



System Components



- Low frequency and high frequency field generators
- Camera system
- Electrical control system
- A solar power unit, survives field conditions
- Real time field measurement

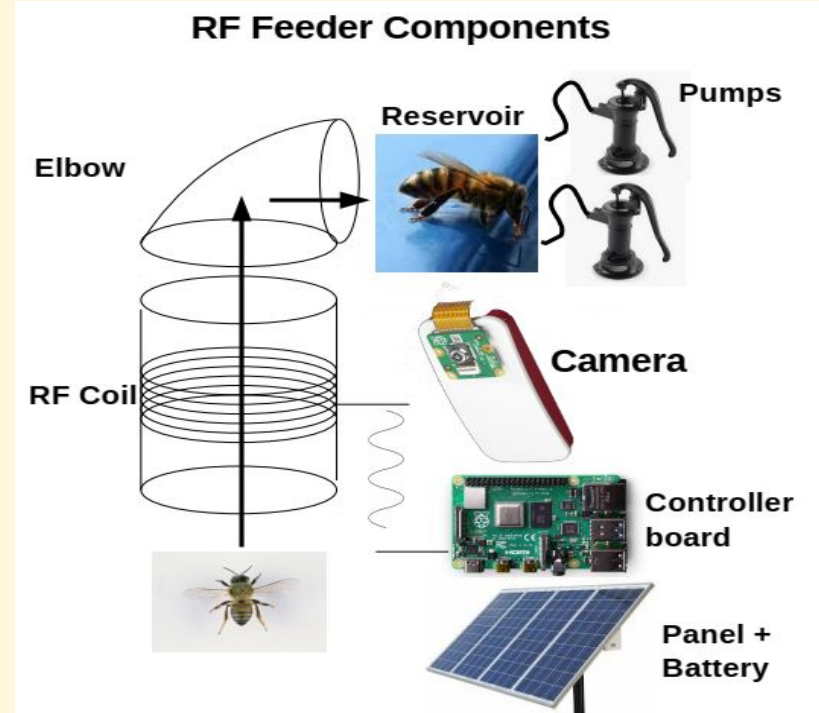



Field Generation

- Static:
 - 700 turn bunched solenoid (4X175 turns)
 - Allows easy tracking of bees
 - Magnetic field is still fairly uniform
- RF (dynamic):
 - Small helical coil under static coils
 - Initial testing to be at 1MHz.

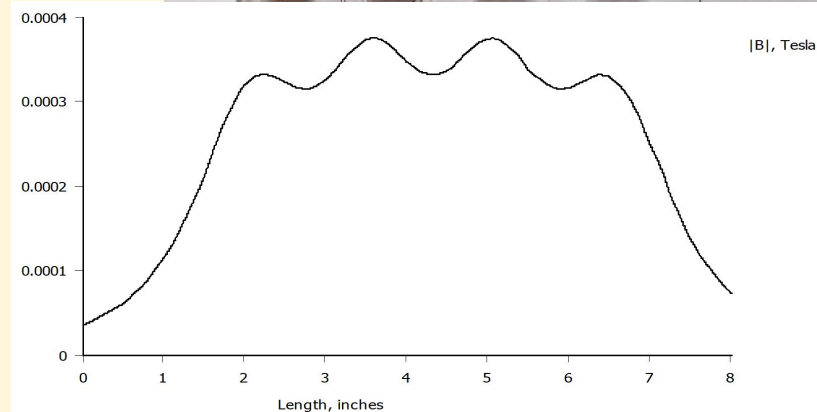
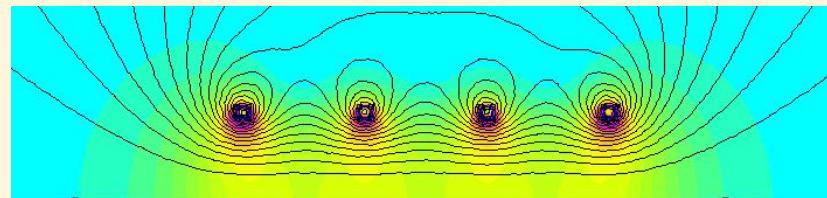



Counting Bees:

Split tube into 4 virtual sections.

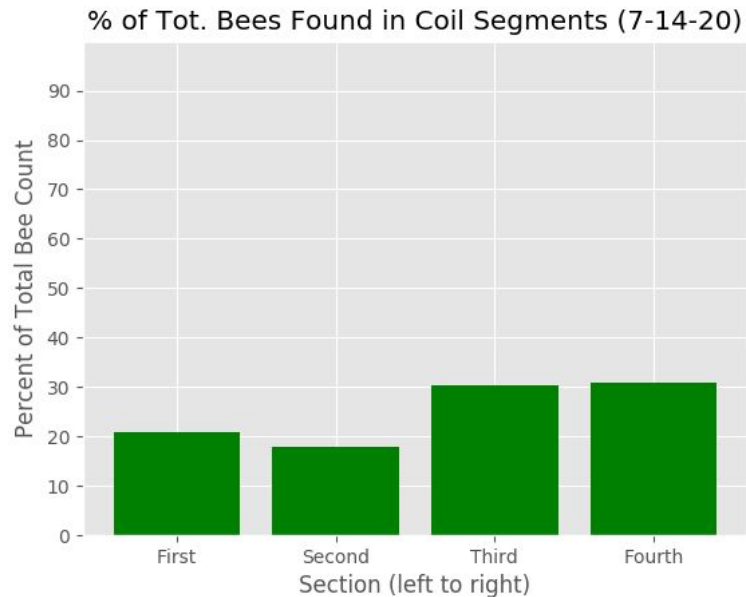
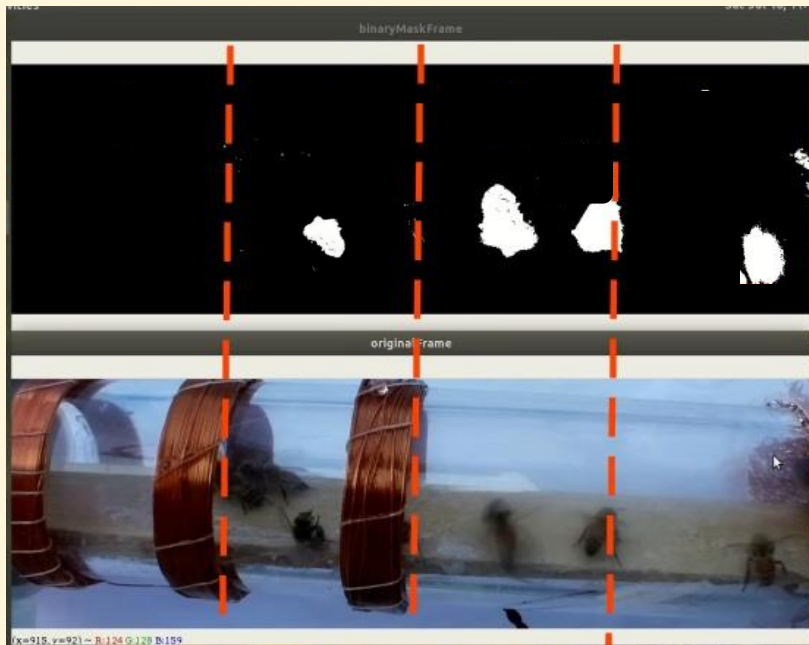

Tracking Bee Movement:

Analyze patterns in response to radio waves.

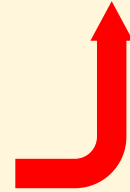
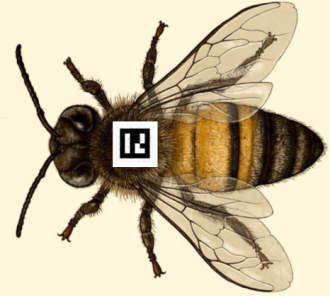
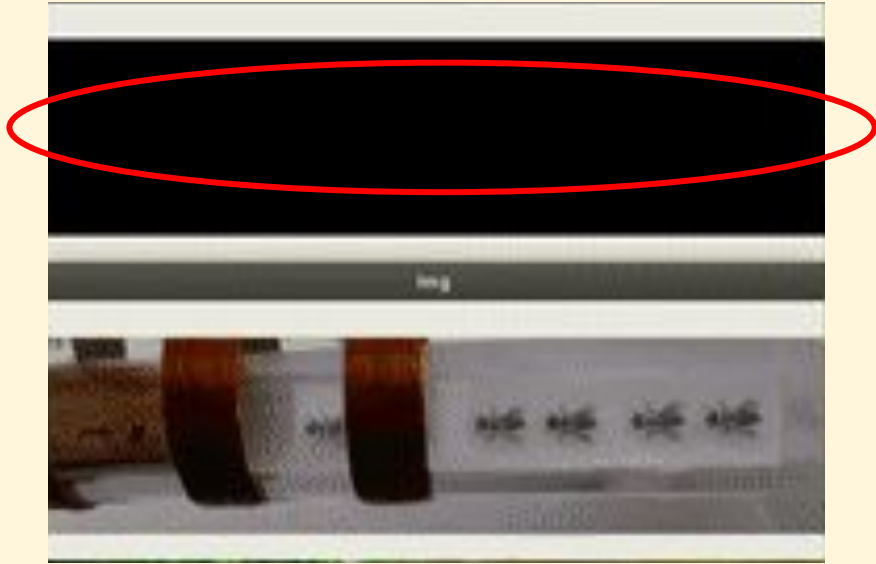

2mm x 2mm Marker Code



Electrical Control System

- Pump/drain sugar/bitter/rise water (12V)
 - Pumps and trap door
- Raspberry Pi (5V)
- Field Coil (3.3V)
- Measure ambient light to detect day/night
- Control two relays for the static field coil

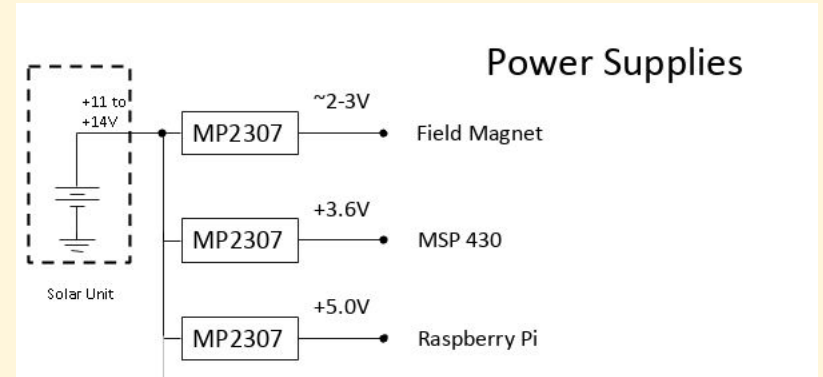



PCB Design:

Relay Connection & Customized Library

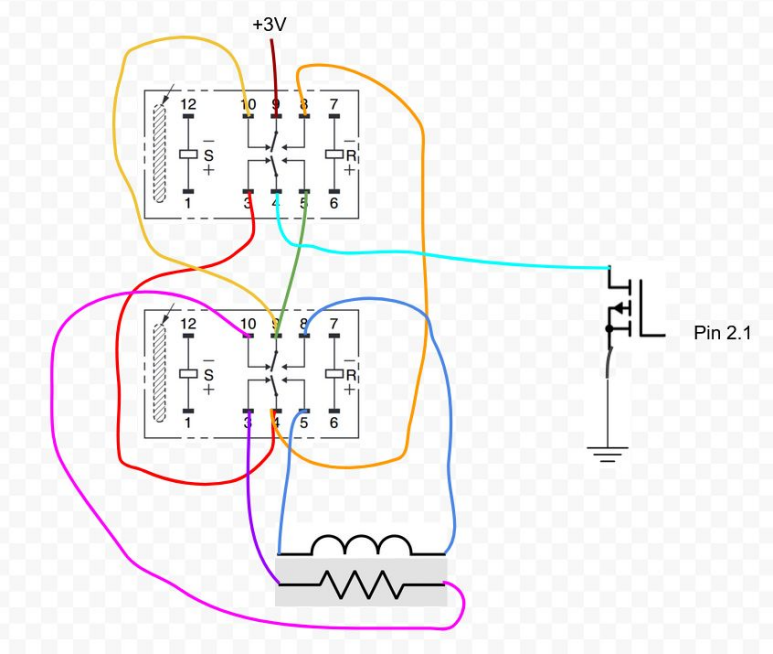

Figure 1: Relay Connection

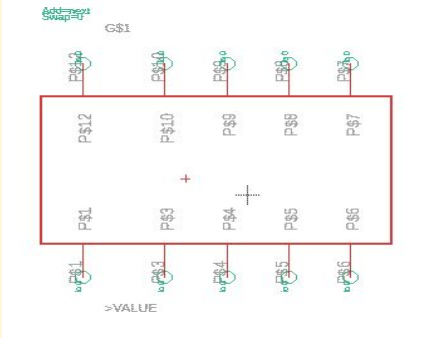

Figure 2: Symbol in Schematic

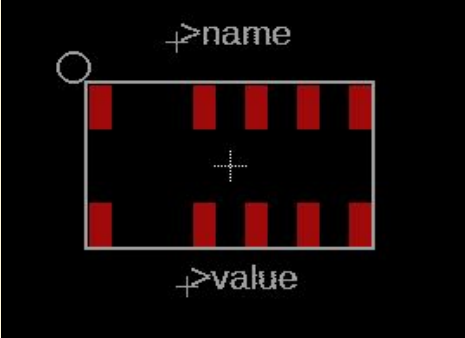

Figure 3: Footprint in Board View



**Resources From
& Built Based On**



Relay Documentation:
https://omronfs.omron.com/en_US/ecb/products/pdf/en-g6s.pdf

PCB Design using EAGLE

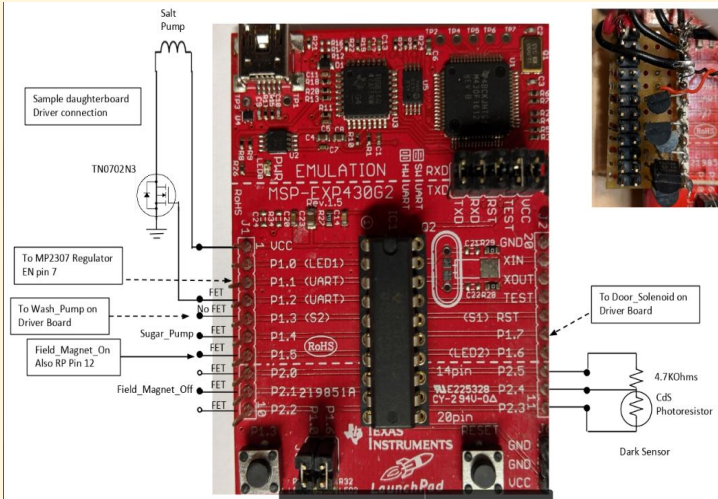

Figure 1: Control Layout

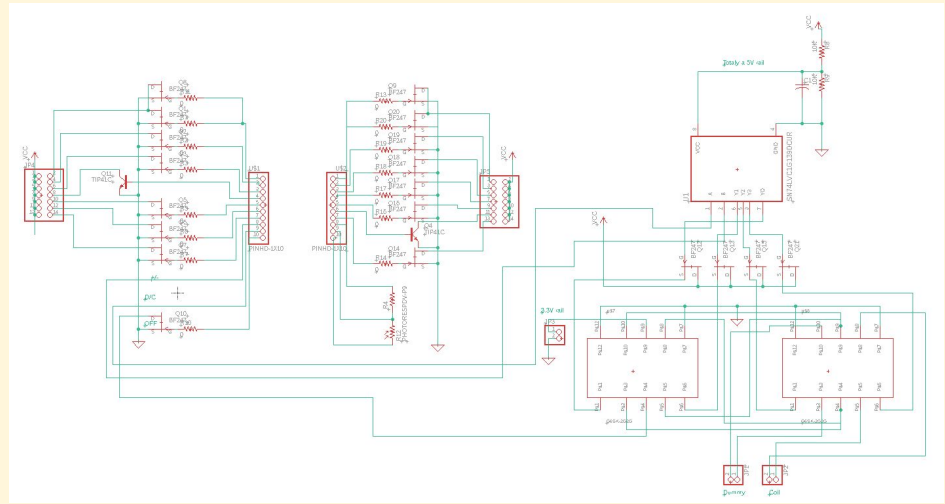

Figure 2: Version 2.1

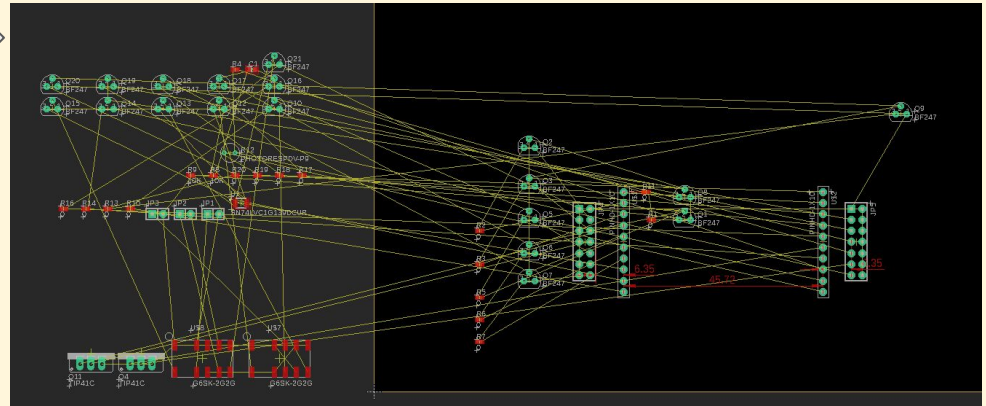
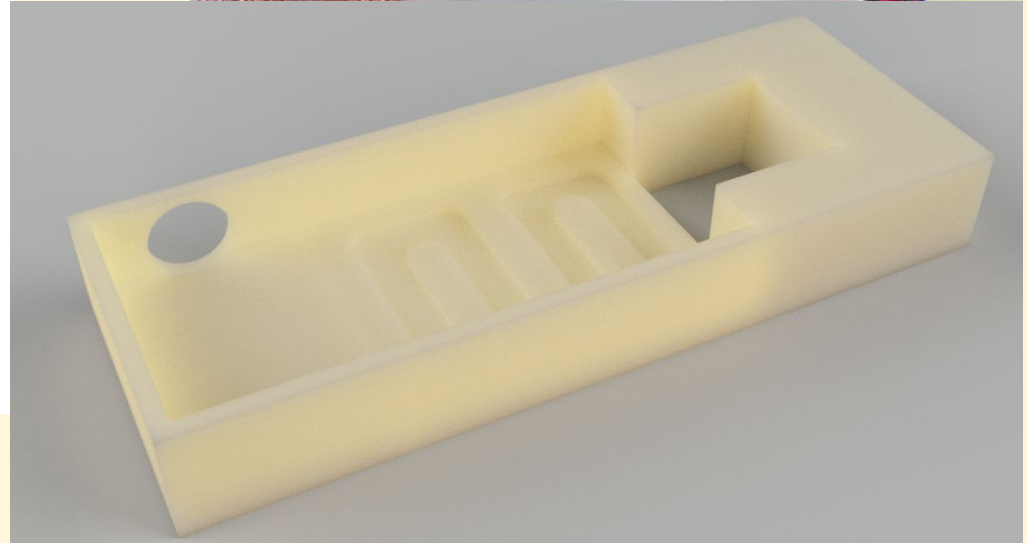
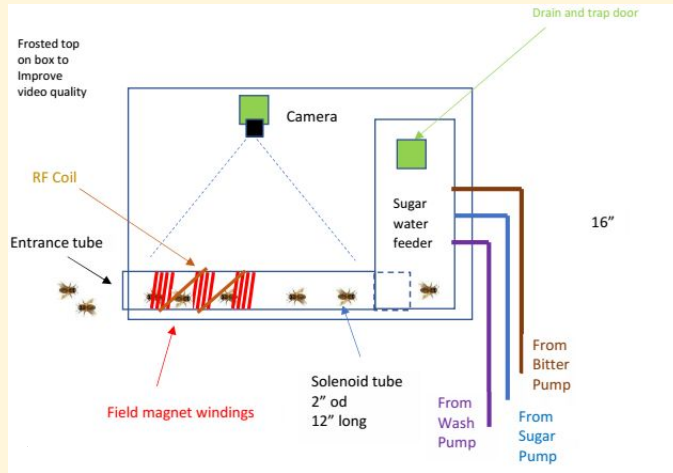
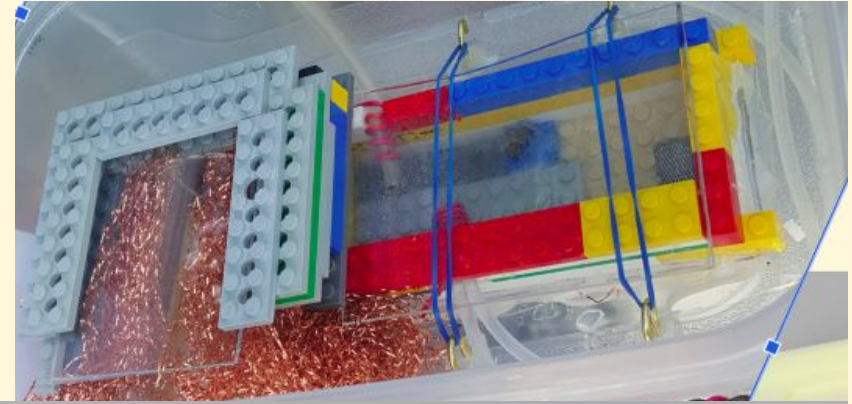

Figure 3: Version 2.1 Board View



3D printing feeder design

- The current design is lego
- 3D printed design will be watertight
- More bee friendly feeder structure





Magnetic field sensing

- We use PIP-Tag and a magnetometer to measure the magnetic field strength.
- Data is transmitted wirelessly.
- Data can be viewed in real-time.

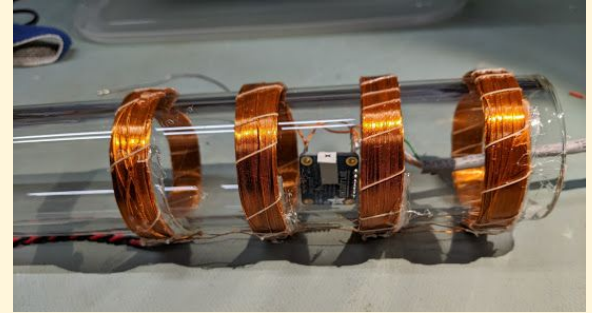

Recent Findings

7-25-20

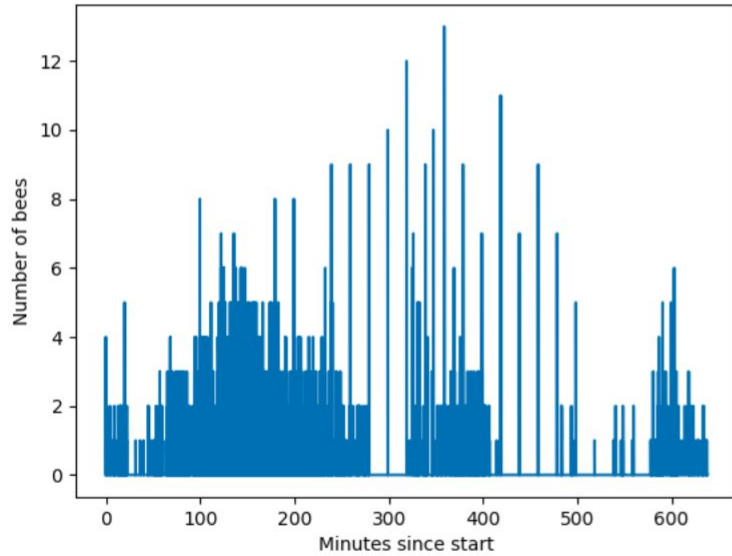

7-26-20

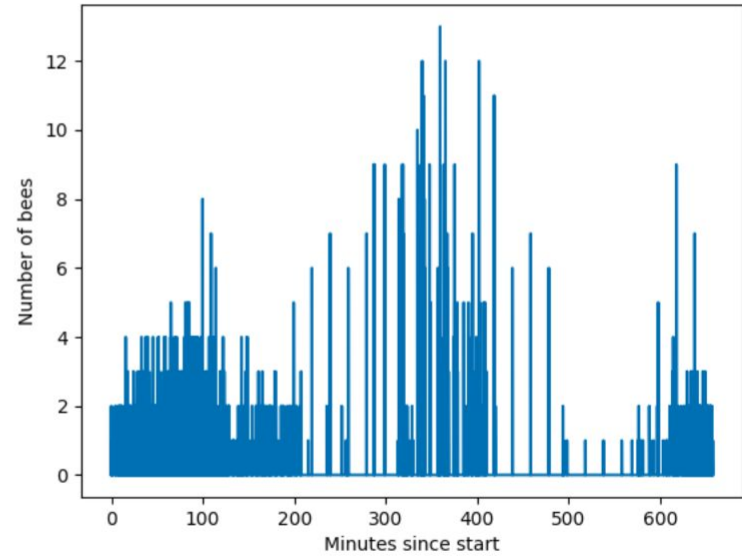



Future Work

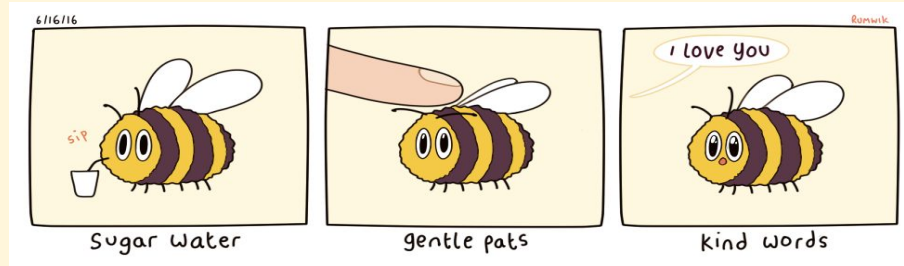

This project is not over! Field work will continue at least until the first frost.



Questions?



THIS SLIDE IS LEFT INTENTIONALLY BLANK



Previous Studies

- Training a few marked honeybees using unnatural punishments, e.g. an electric shock.
- A few bees (in a lab) were exposed to observe their proboscis extension reflex (PER) after associating field exposure to food

